

SKOTSTEK

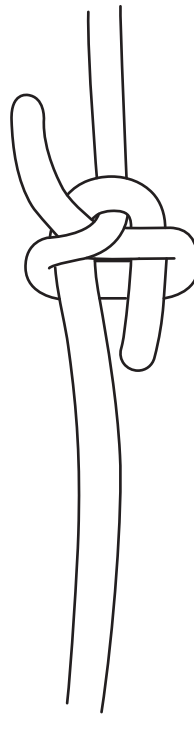

För att binda ihop två rep av olika tjocklek

FISKARSTEK

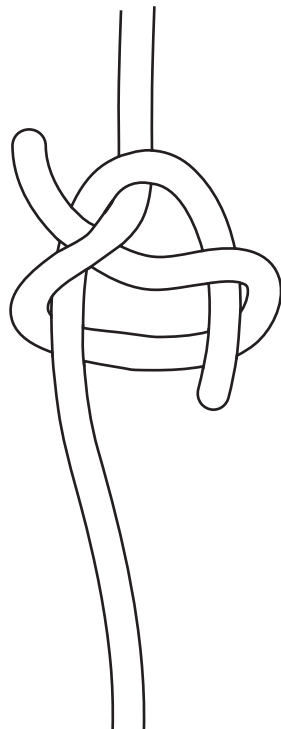
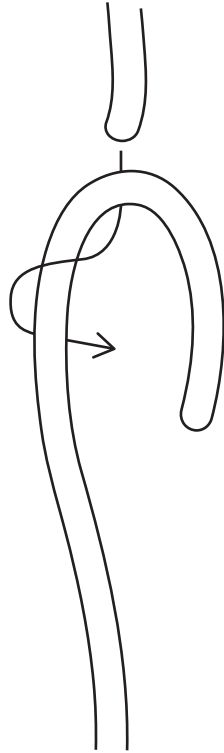
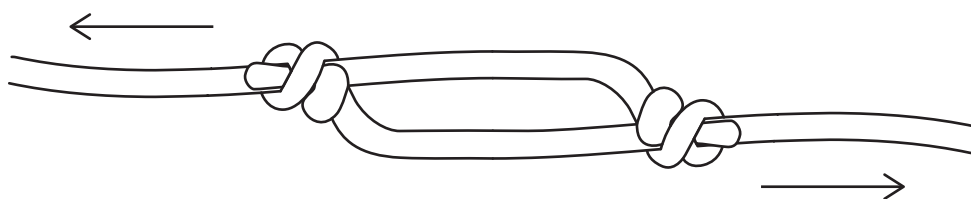
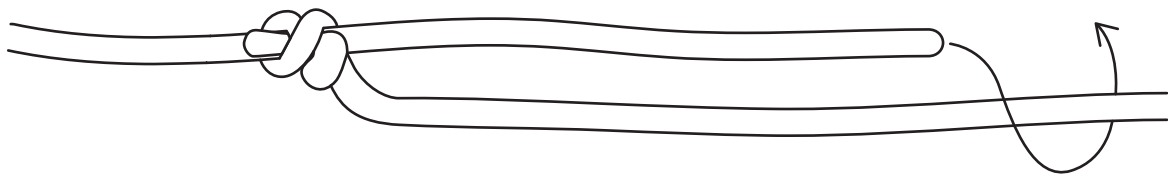
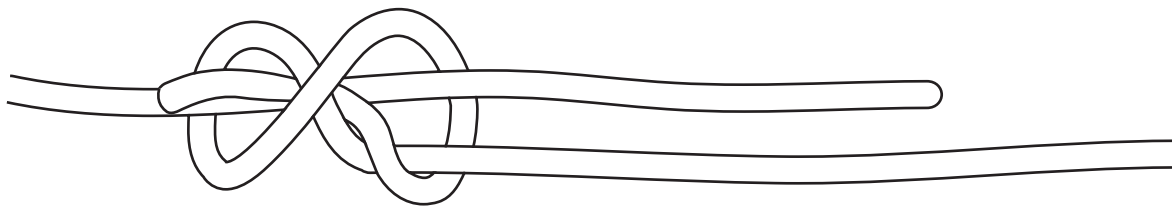
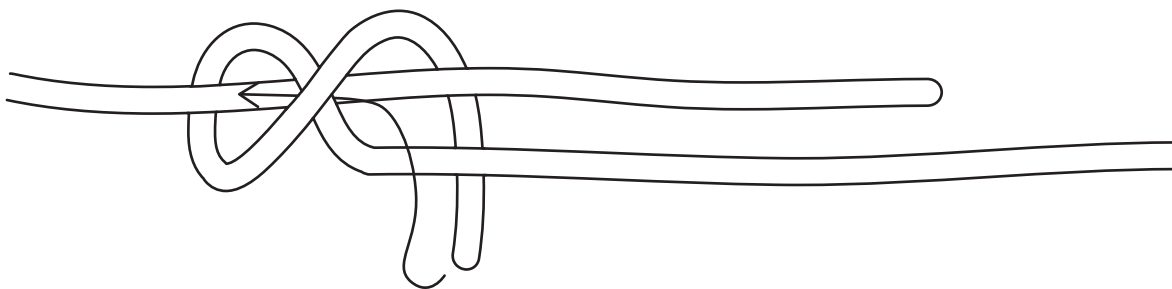
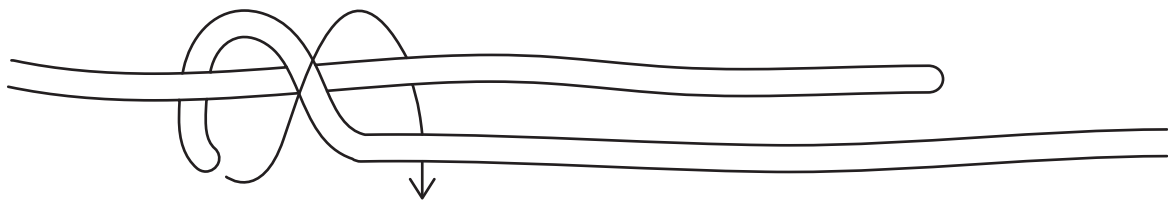

För att binda ihop två rep av samma tjocklek

PÅLSTEK

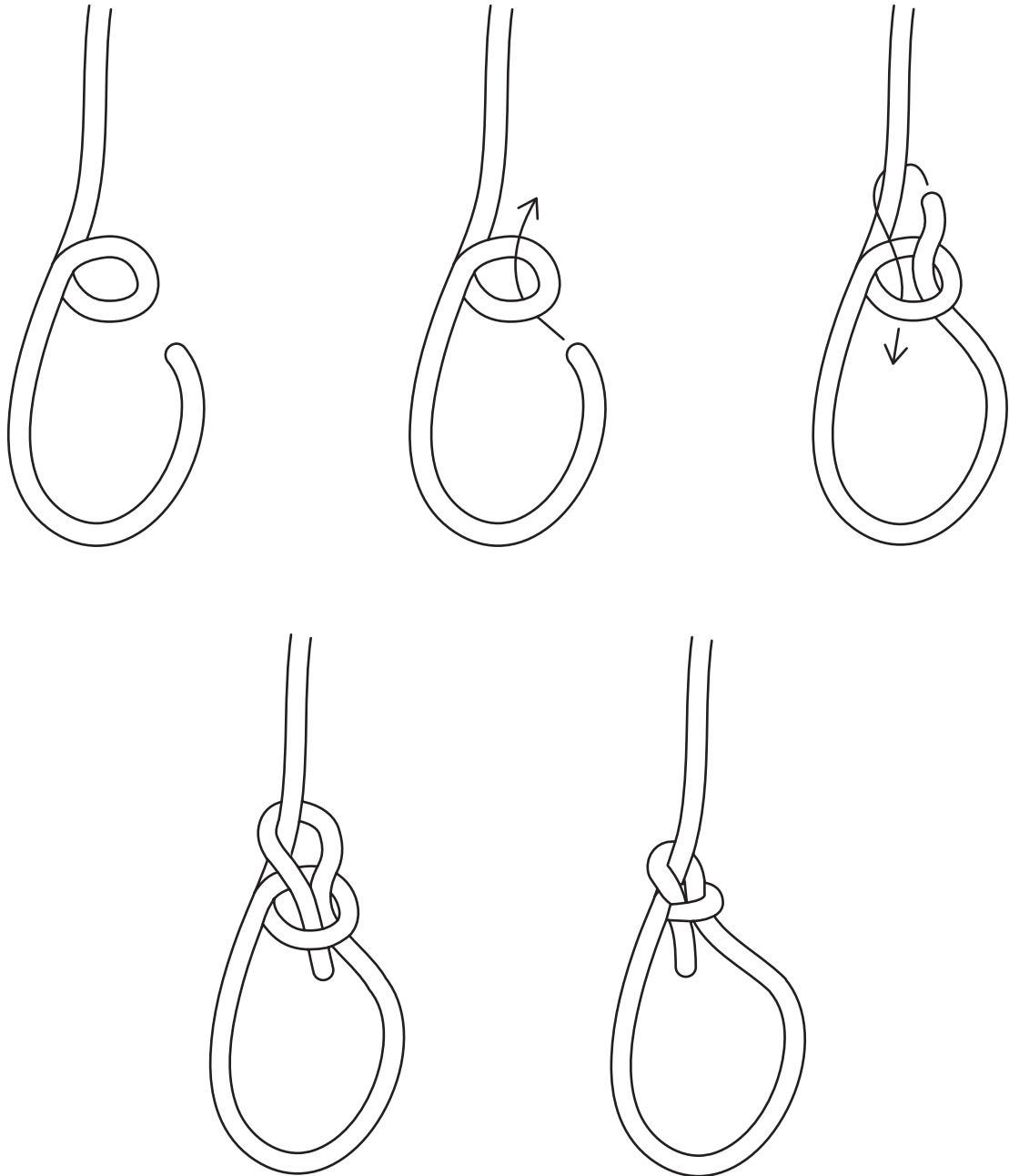

För att skapa en fast ögla

ÖVERHANDSKNOP & ÅTTA

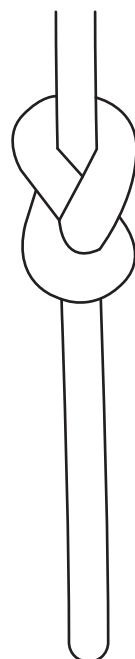
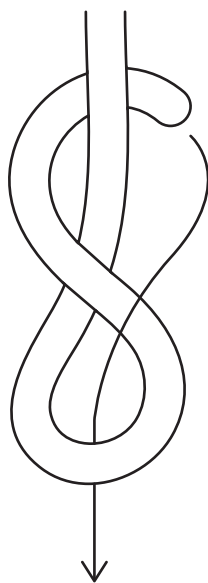
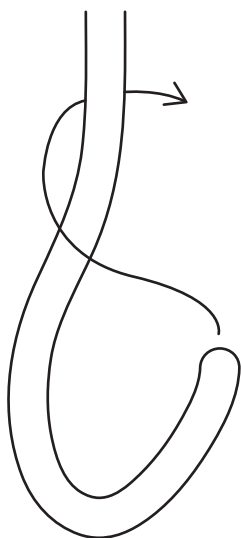
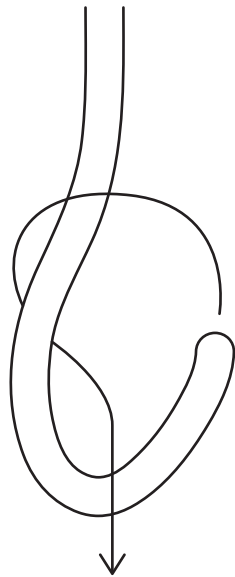

Två bra stoppknoper

PRUSIKKNOP

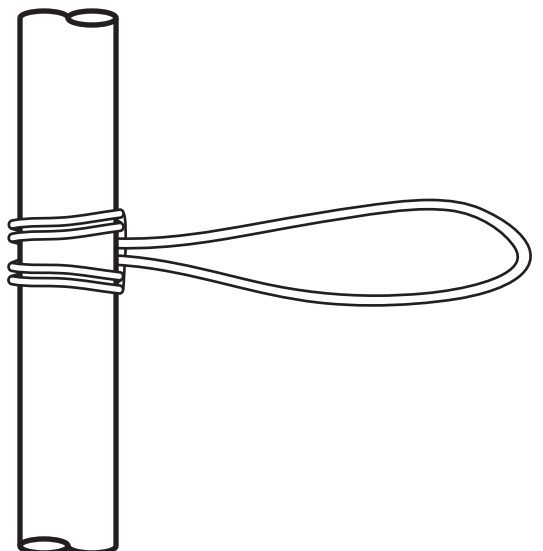
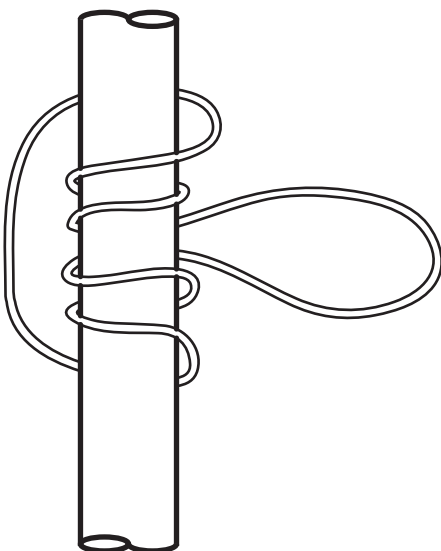
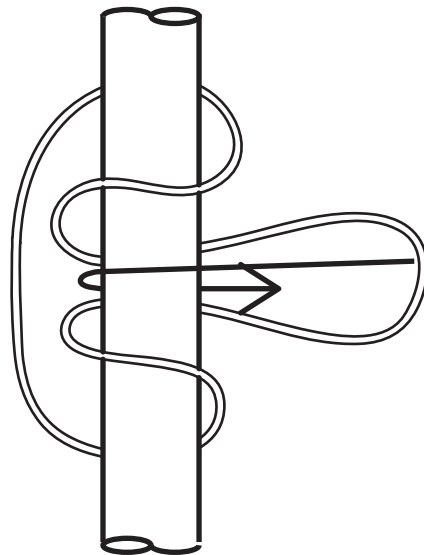
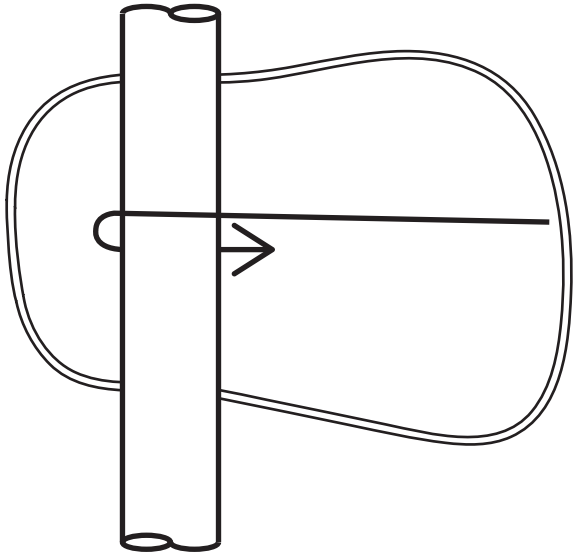

En flyttbar ögla som låser sig vid belastning

RÅBANDSKNOP

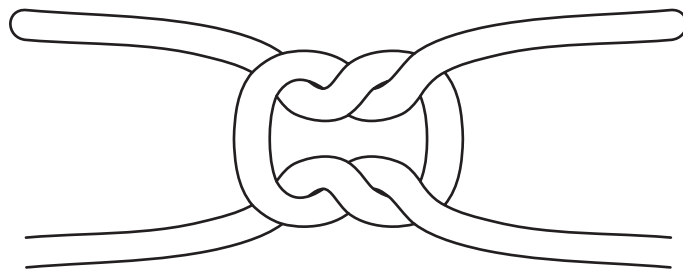
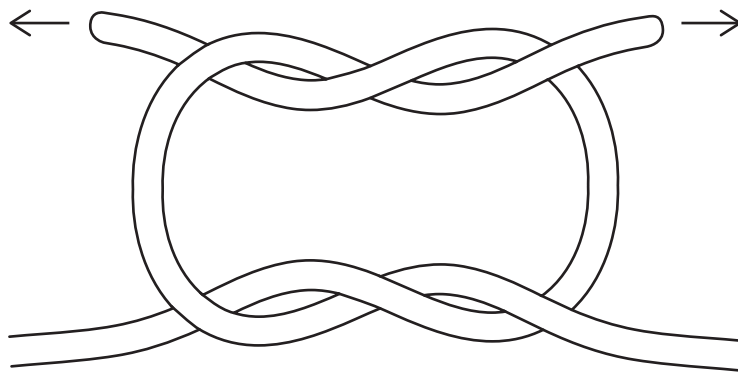
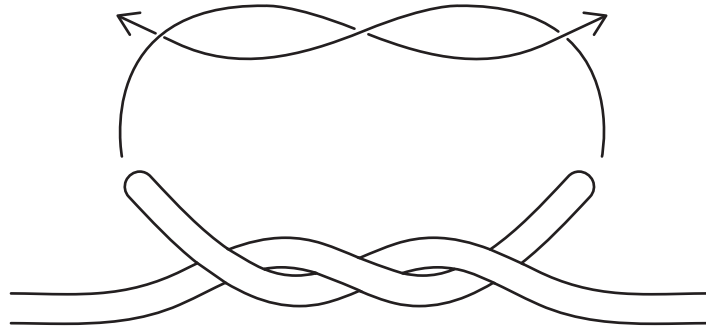

Ett enkelt sätt att säkra en överhandsknop

TRUMPETSTEK

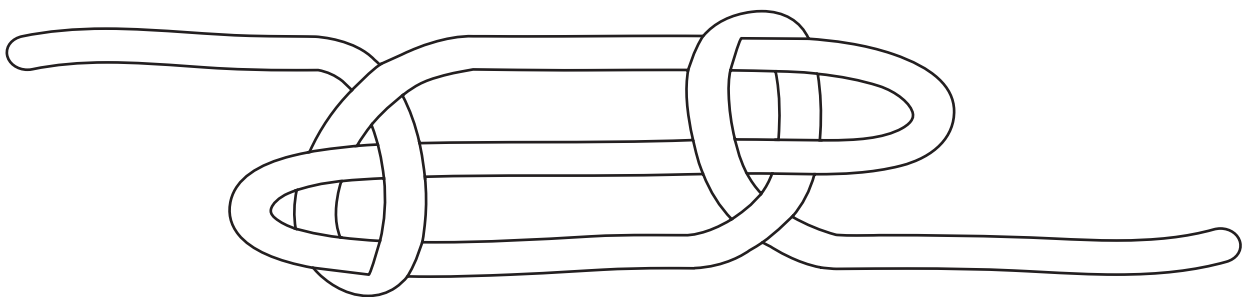
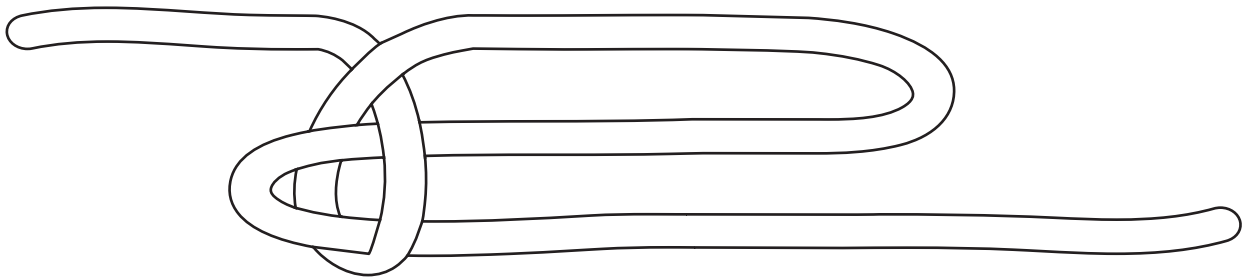
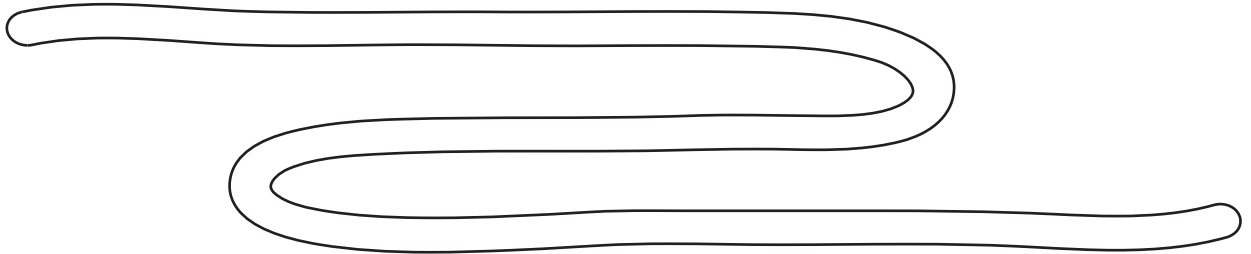

För att korta ett för långt rep

HÄNGSNARA

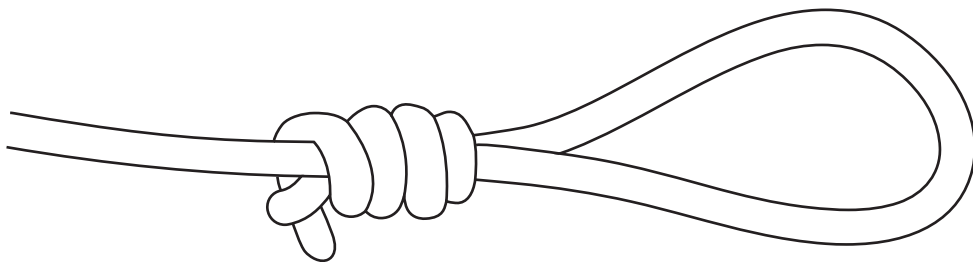
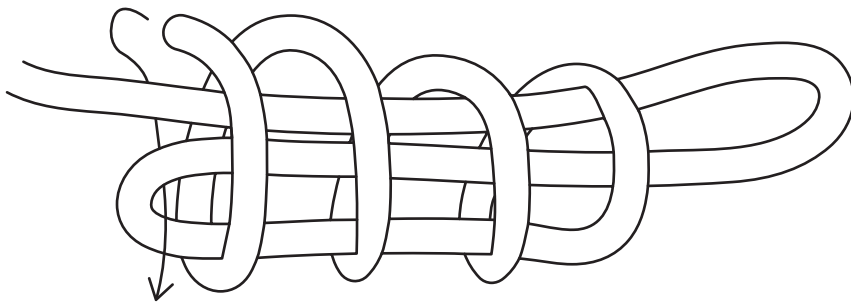
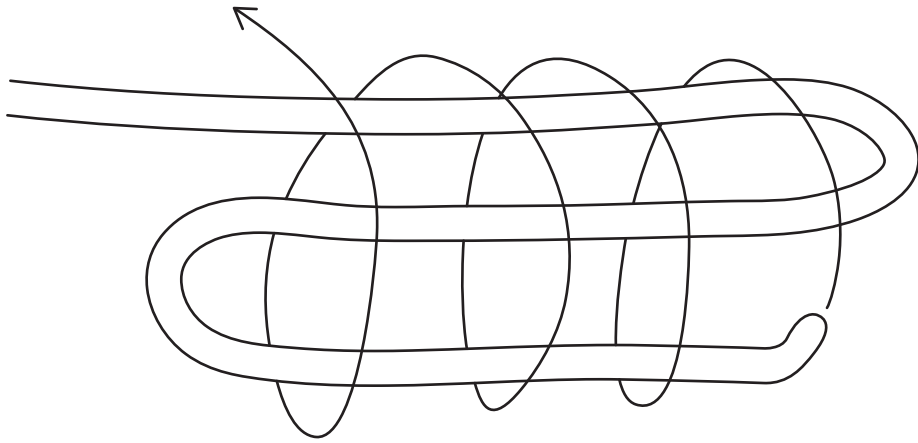

En löpögla som är lätt att dra åt

DUBBELT HALVSLAG

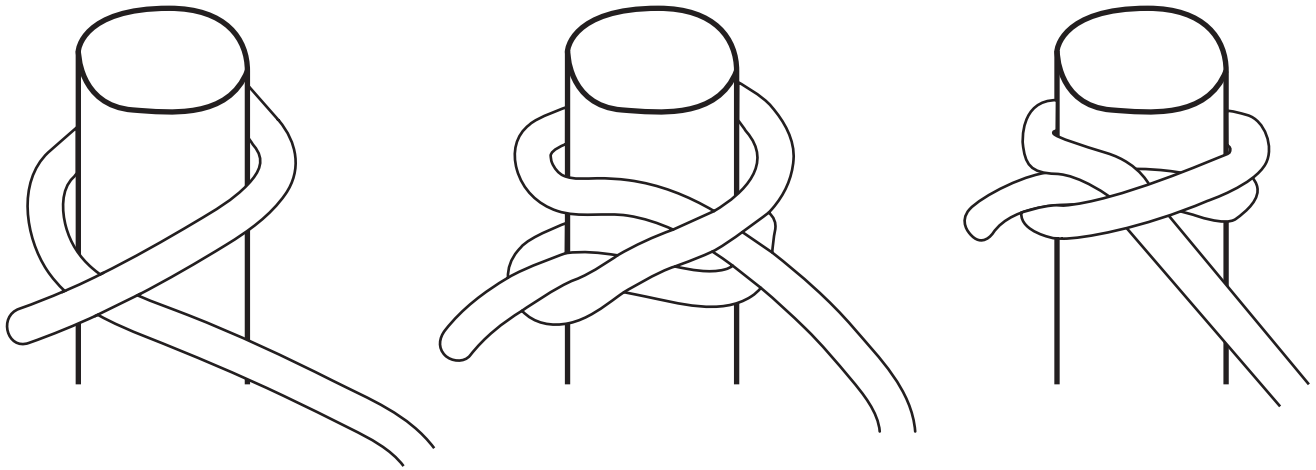

...runt egen part.

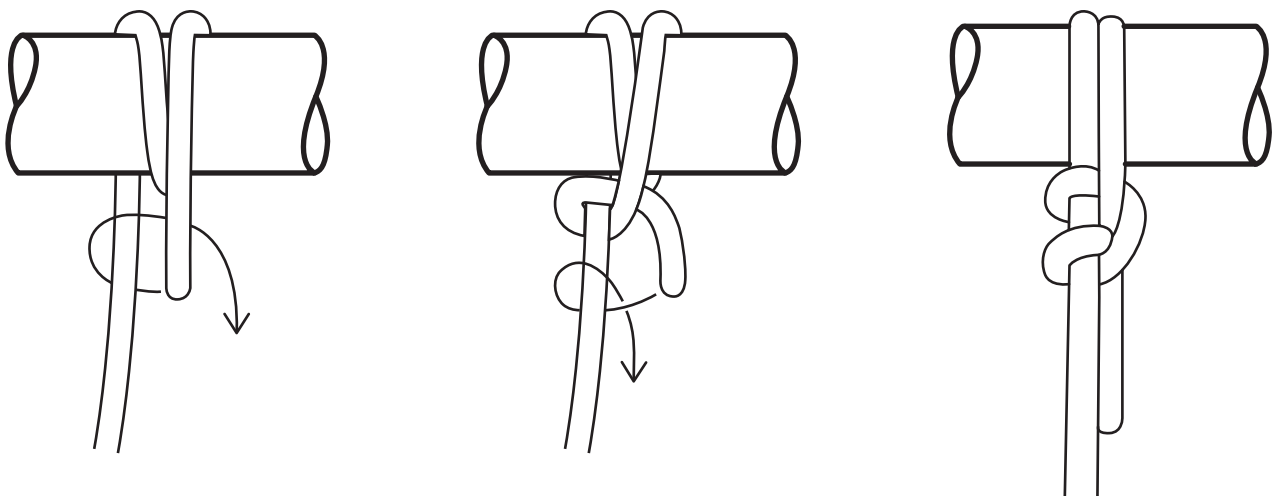

Knop för att fästa repändar i något

TÄLTLINEKNOP

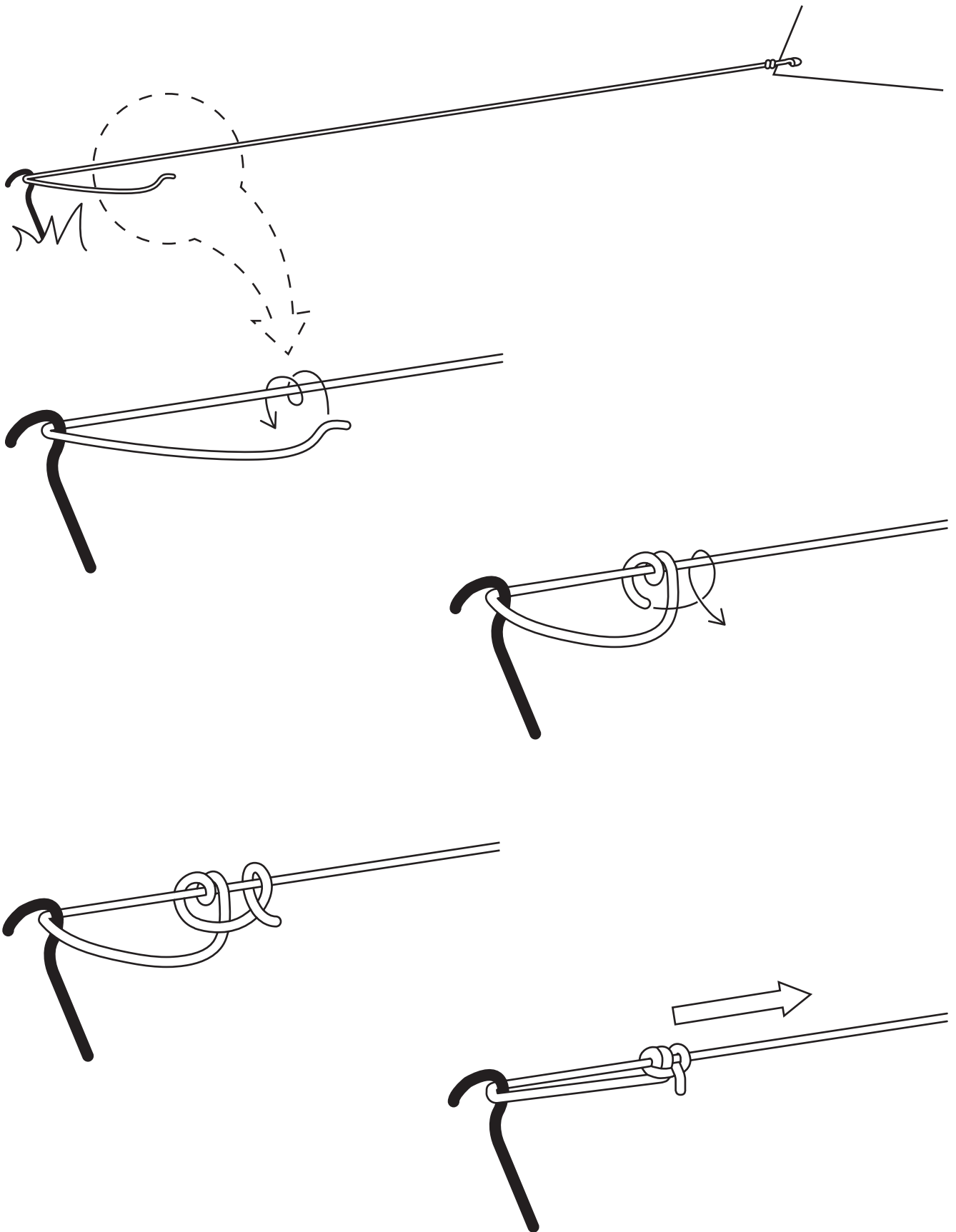

För att spänna en tältlina

TIMMERSTEK

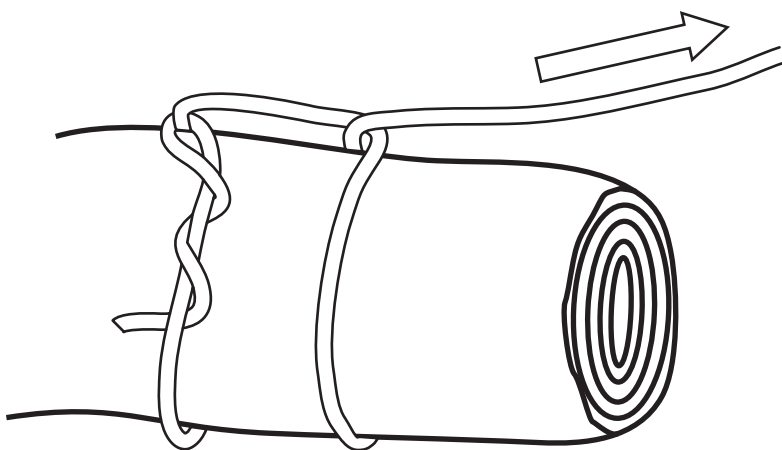
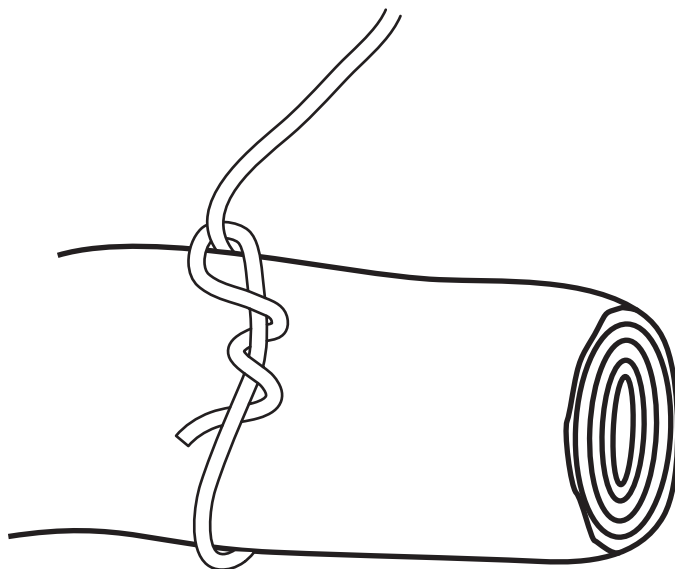
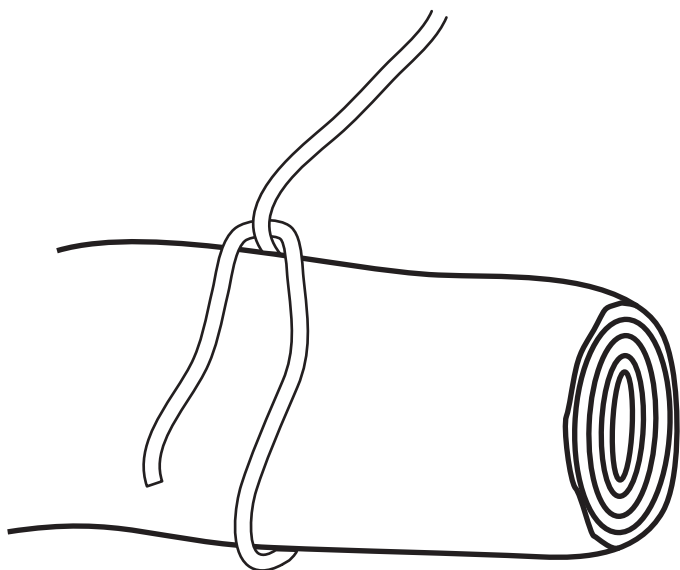

För att släpa stockar och liknande

TRUCKER'S HITCH

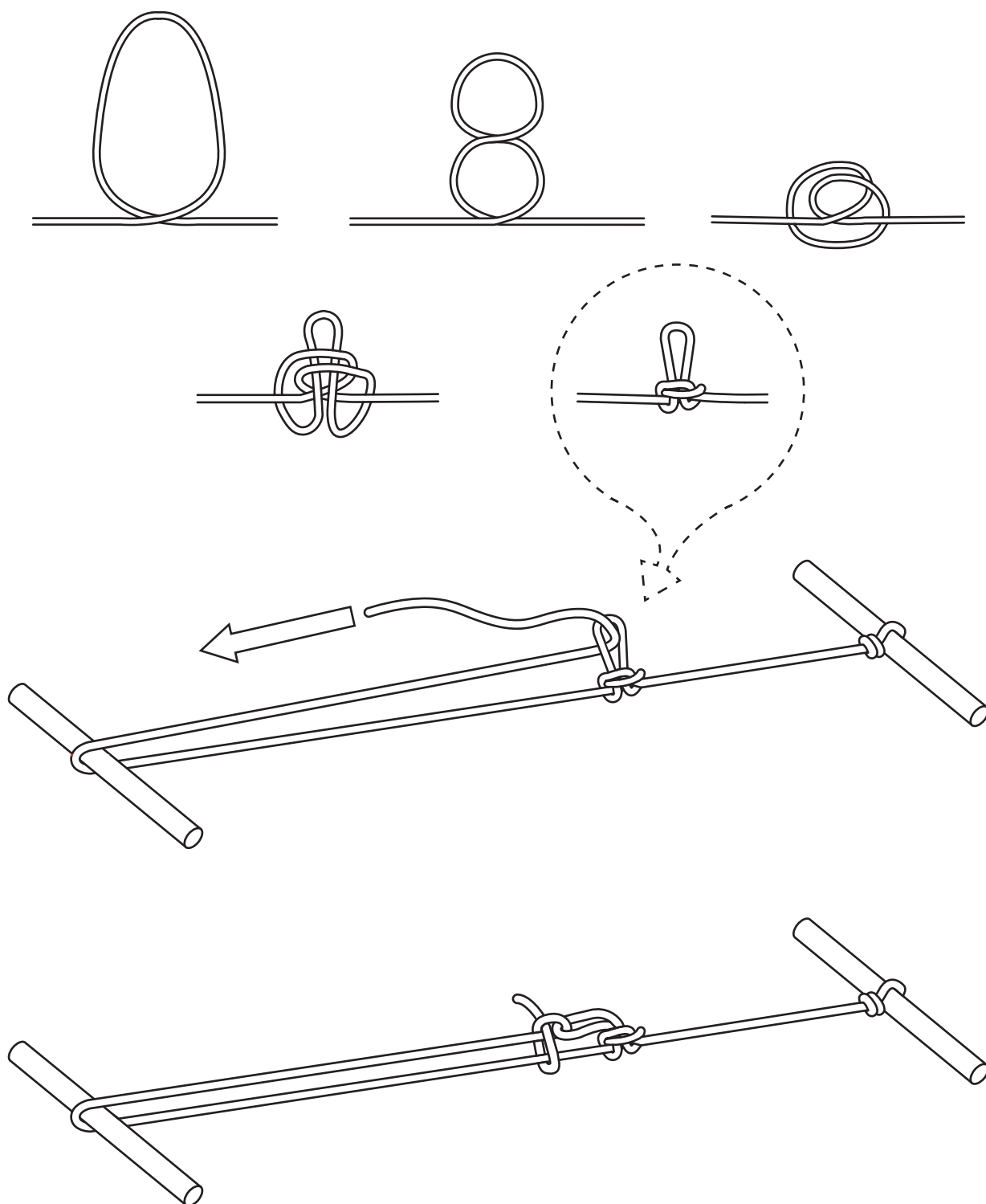

Perfekt för att spänna fast en last

© MARCUS VILDIR 2018

Kopieras fritt för icke vinstdrivande undervisning. För andra ändamål, kontakta mig först.

**verktygsvaggen@vildir.se
<http://vildir.se/verktygsvaggen>**