

Hemliga lådan

Lådans lock låser sig när nitarna glider in i lockets tvärsår.
För att låsa upp behöver du snurra lådan, så att nitarna drar sig utåt av centrifugalkraften.

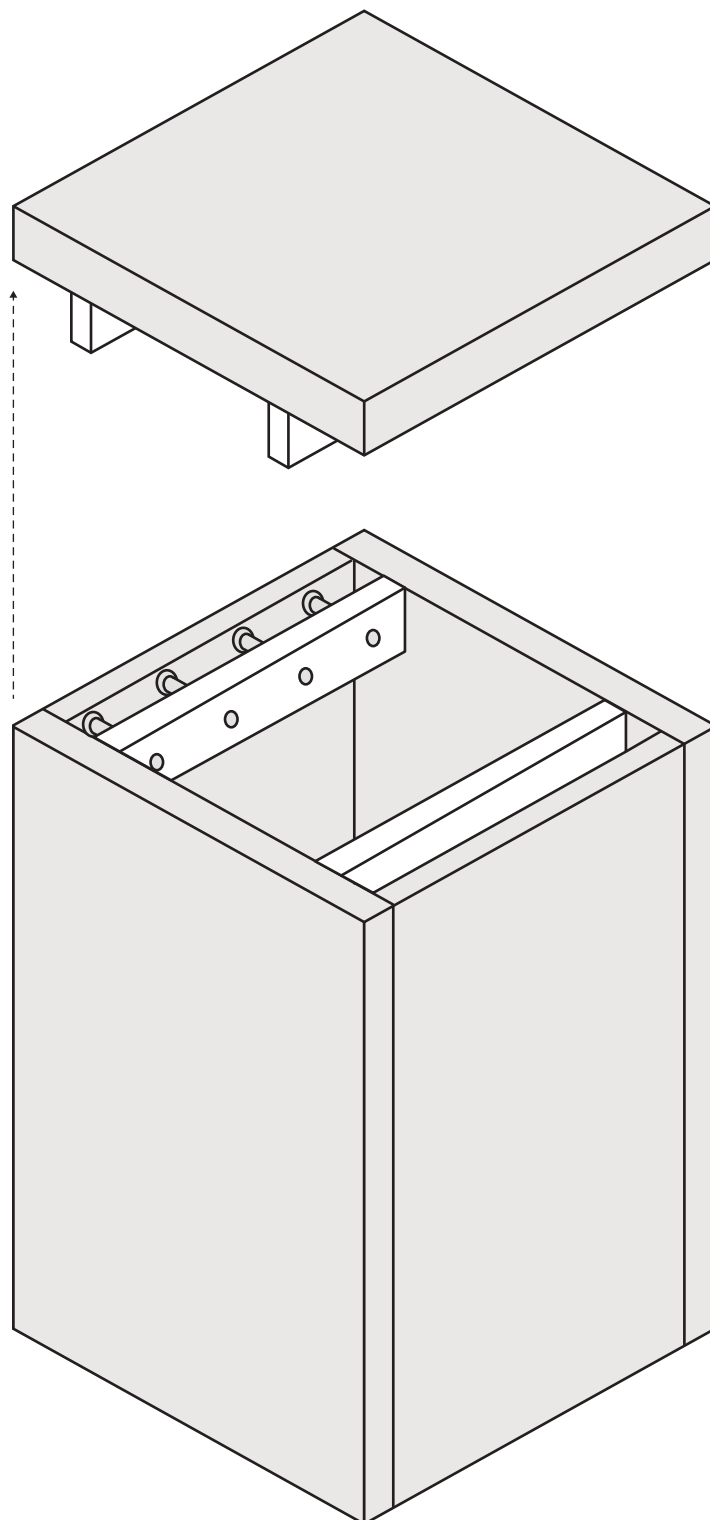

Se länk:

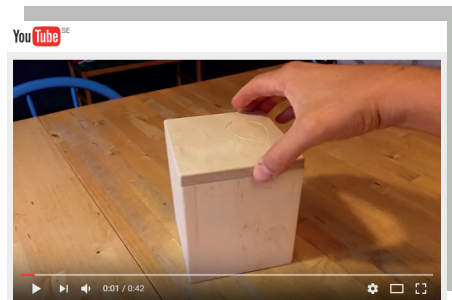

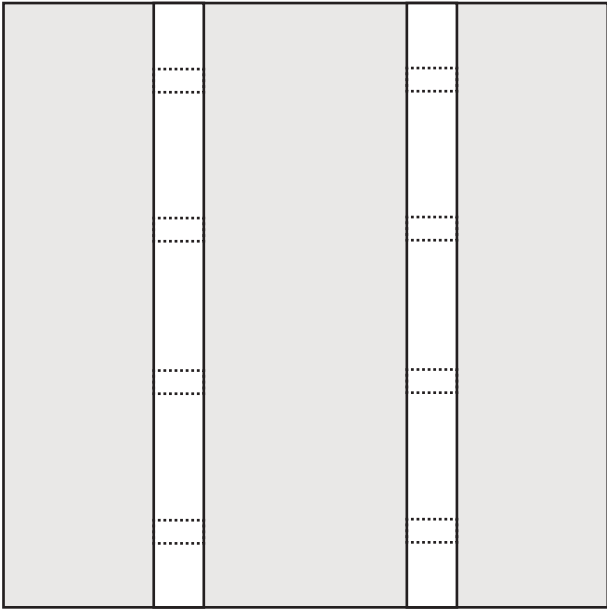

OVANIFRÅN

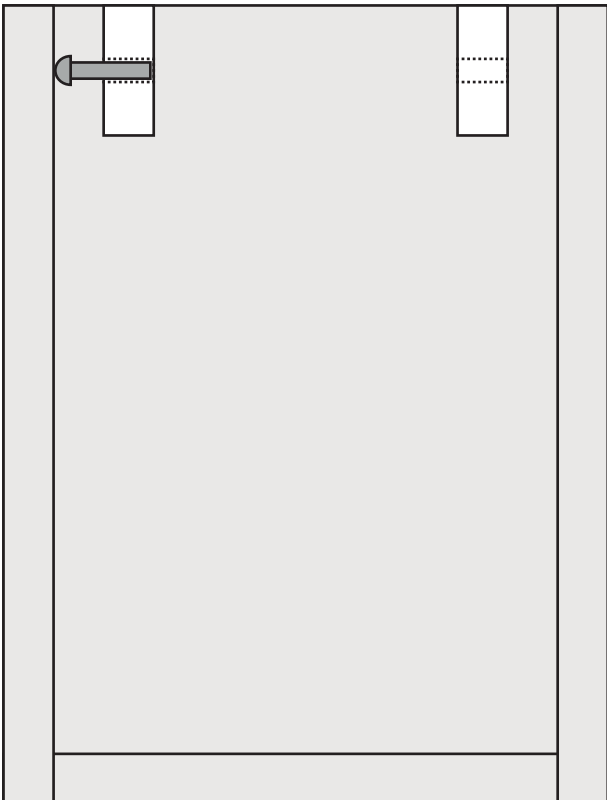
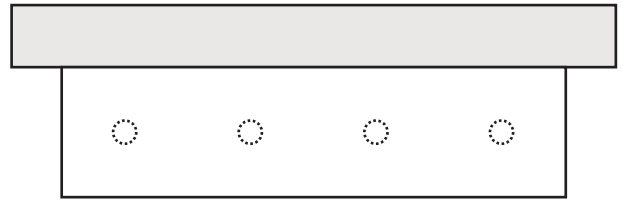
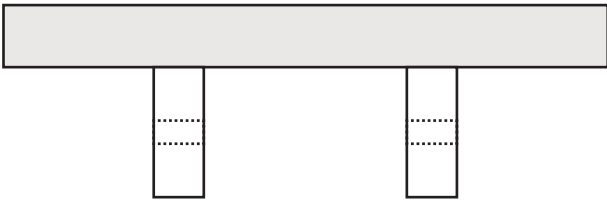

SIDOVY 1

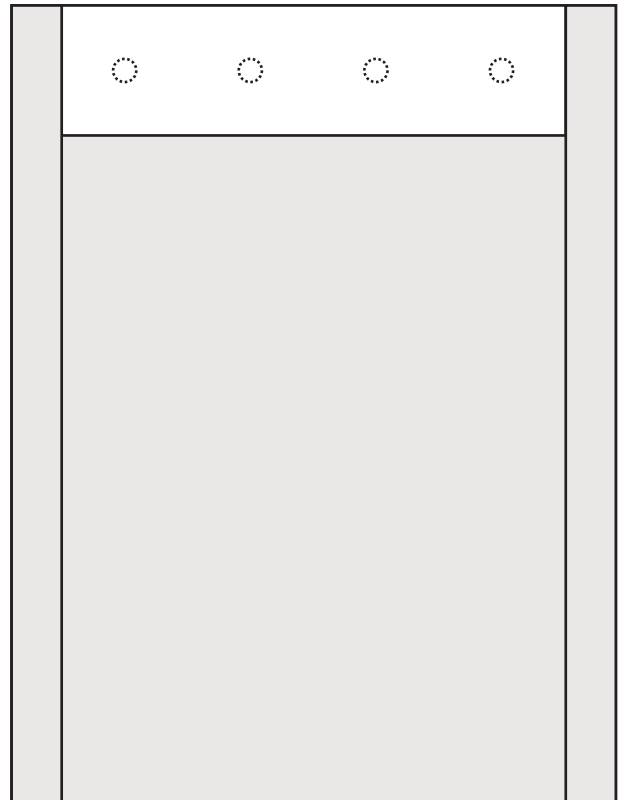

SIDOVY 2